

扬芳 ←

→ 鲸山村

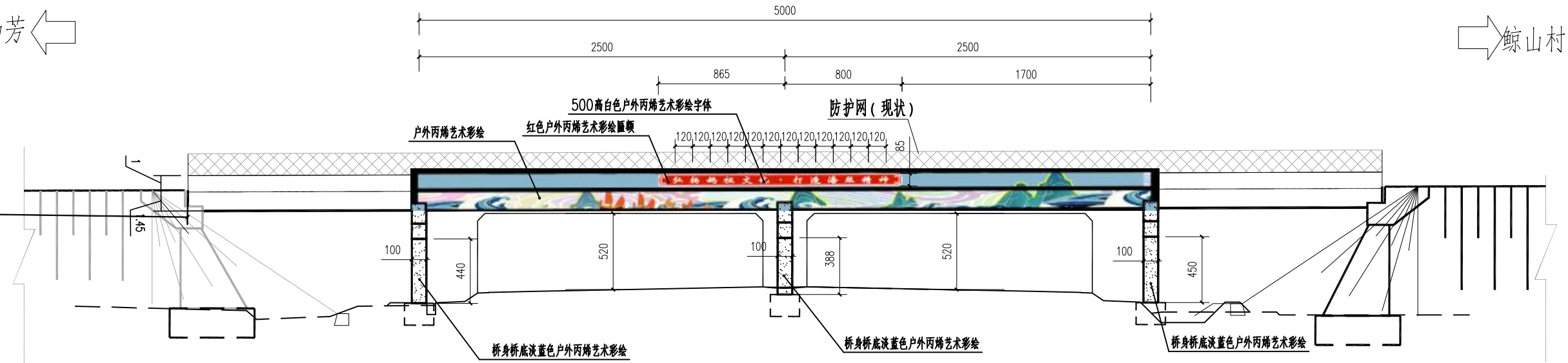

扬芳 ←

→ 鲸山村

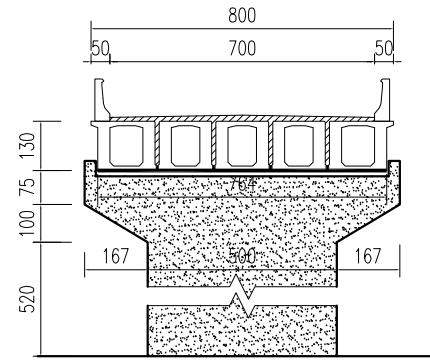
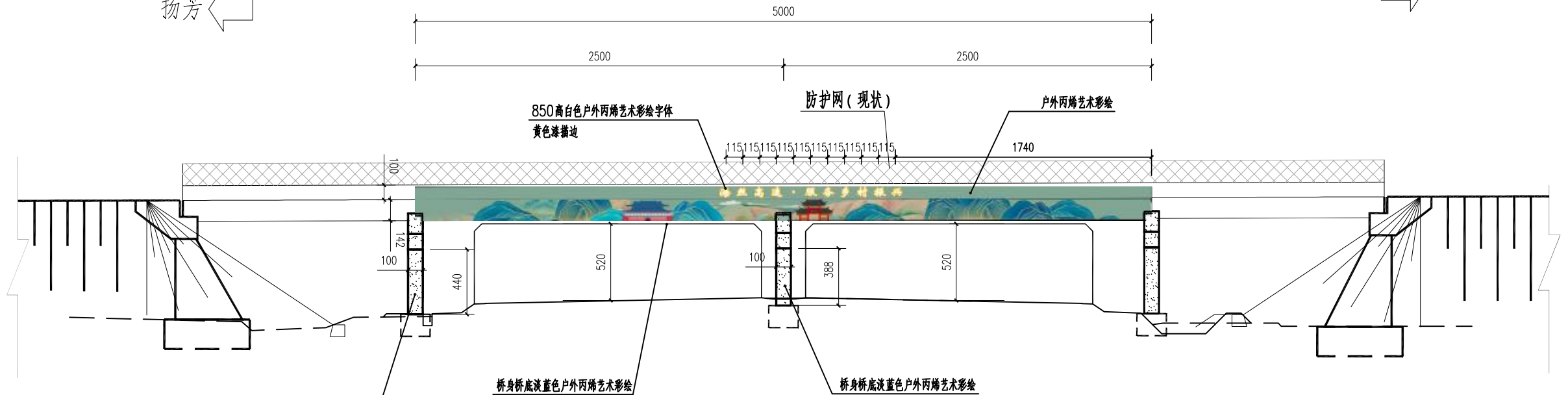







1970-01-14 20:30:50.776 5386



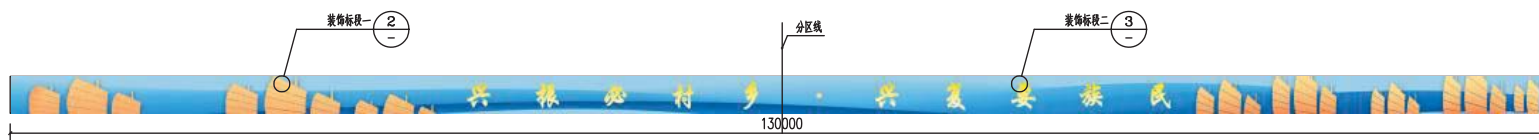

① AK2101+350-AK2101+480 声屏障装饰图 1:300

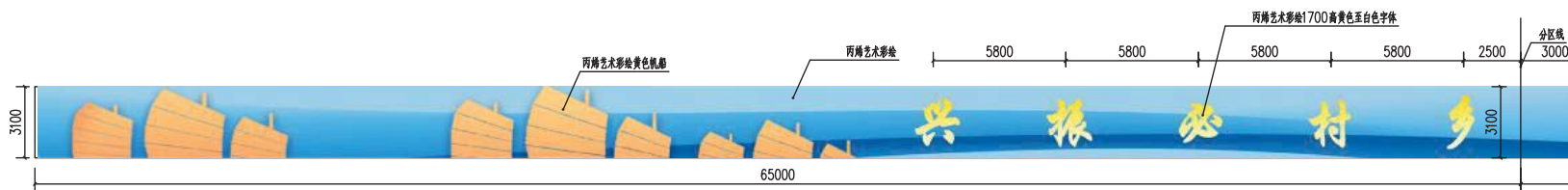

② AK2101+350-AK2101+480 声屏障装饰图标段一 1:150

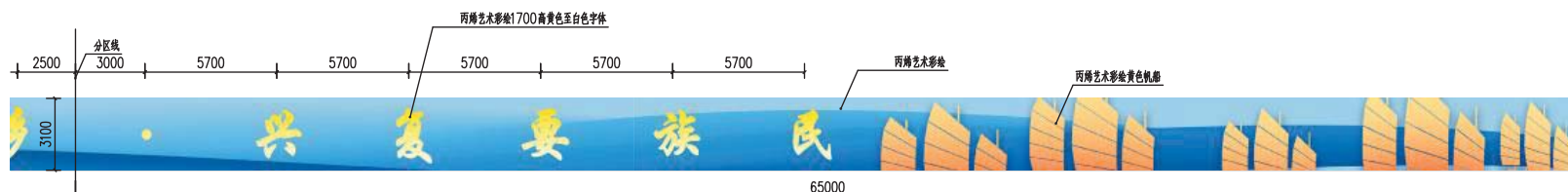

③ AK2101+350-AK2101+480 声屏障装饰图标段二 1:150

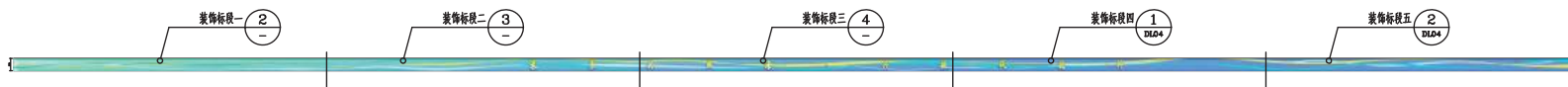

① 飘带雕塑处AK2153+350-AK2153+750声屏障装饰图 1:900

说明：此次为左侧声屏障内侧装饰立面。

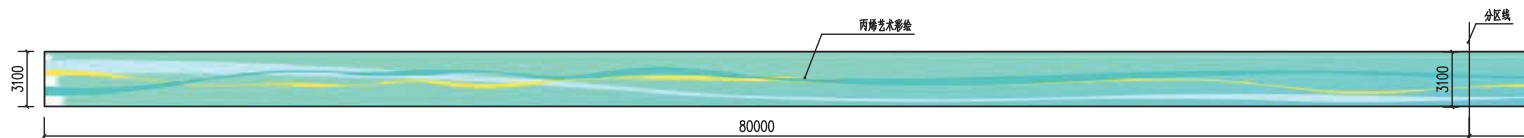

② 飘带雕塑处AK2153+350-AK2153+750声屏障装饰图标段一 1:200

说明：此次为左侧声屏障内侧装饰立面。

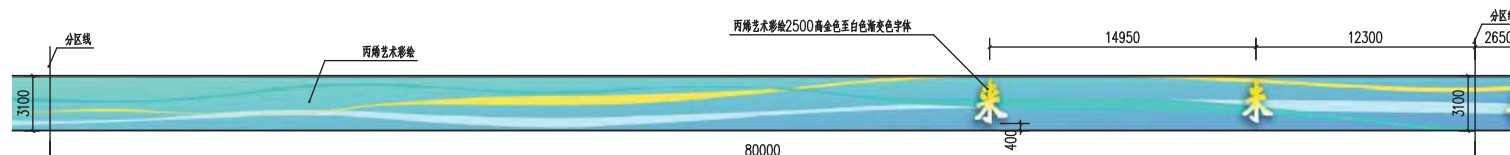

③ 飘带雕塑处AK2153+350-AK2153+750声屏障装饰图标段二 1:200

说明：此次为左侧声屏障内侧装饰立面。

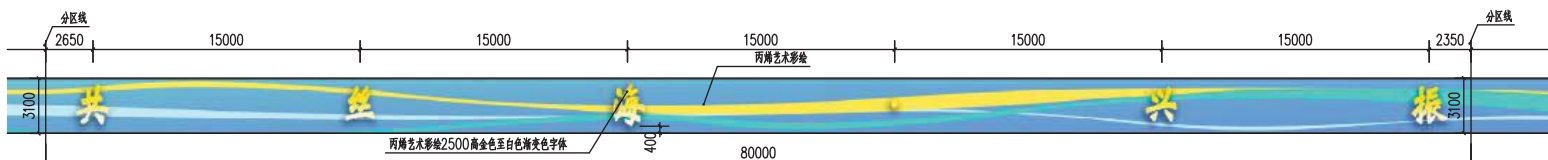

④ 飘带雕塑处AK2153+350-AK2153+750声屏障装饰图标段三 1:200

说明：此次为左侧声屏障内侧装饰立面。

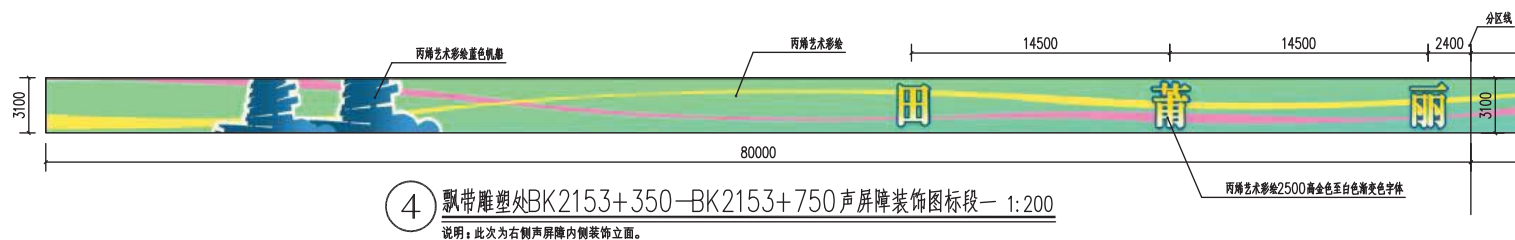
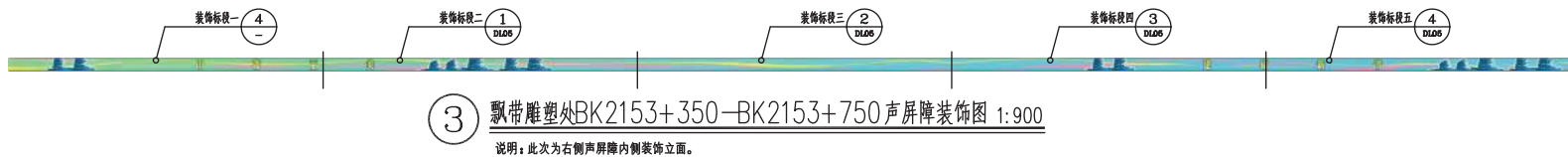
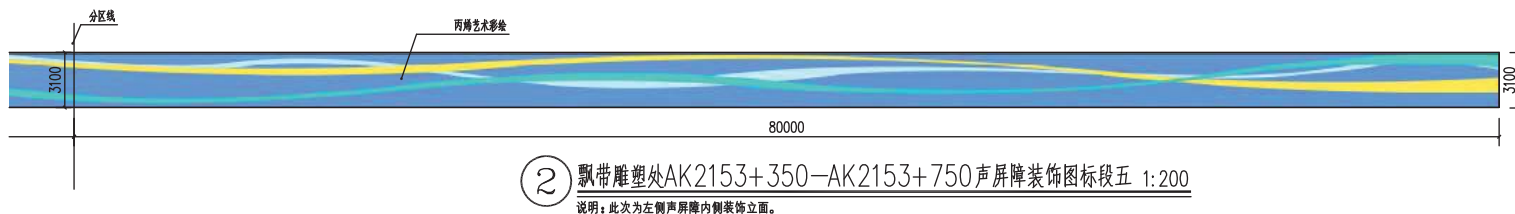
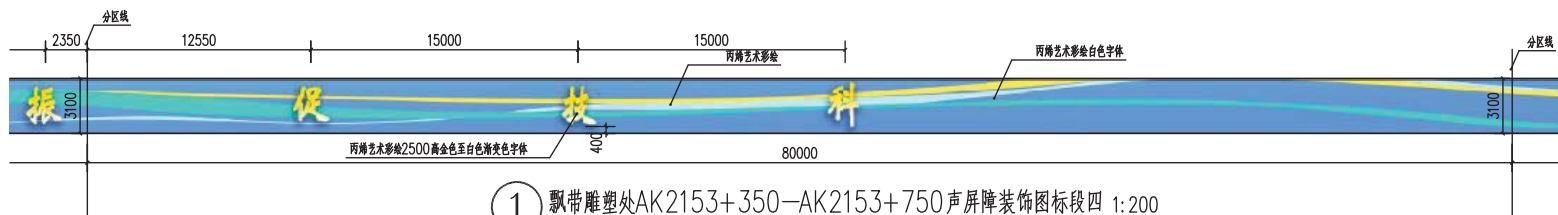

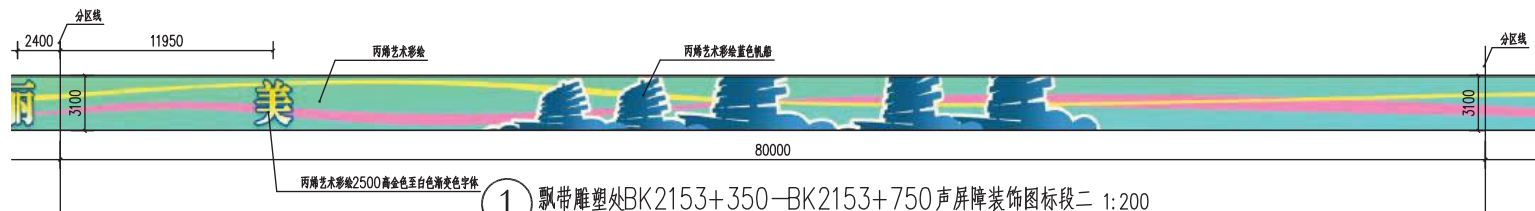

① 飘带雕塑处BK2153+350-BK2153+750 声屏障装饰图标段二 1:200
说明：此次为右侧声屏障内侧装饰立面。

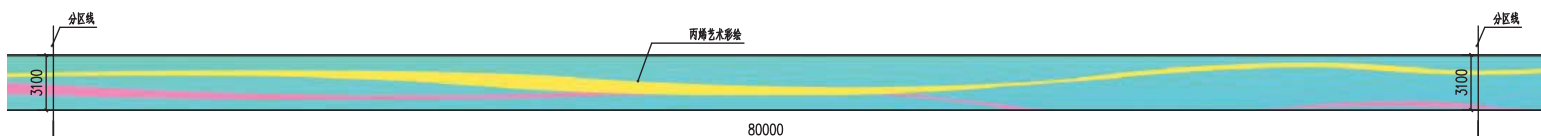

② 飘带雕塑处BK2153+350-BK2153+750 声屏障装饰图标段三 1:200
说明：此次为右侧声屏障内侧装饰立面。

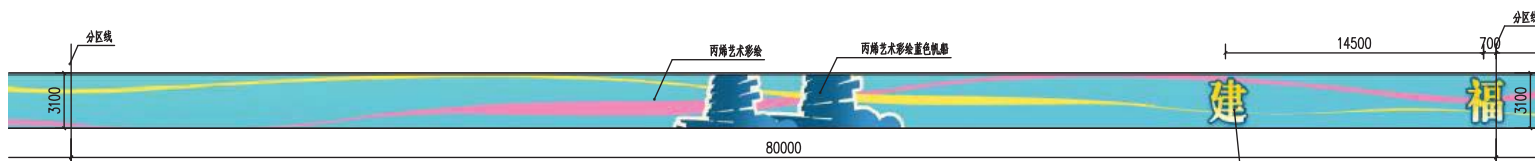

③ 飘带雕塑处BK2153+350-BK2153+750 声屏障装饰图标段四 1:200
说明：此次为右侧声屏障内侧装饰立面。

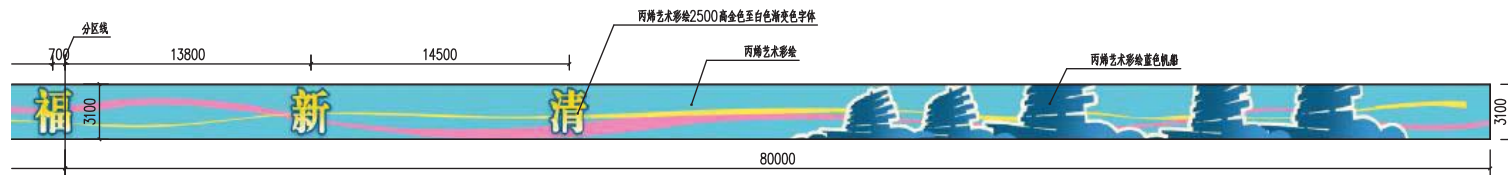

④ 飘带雕塑处BK2153+350-BK2153+750 声屏障装饰图标段五 1:200
说明：此次为右侧声屏障内侧装饰立面。

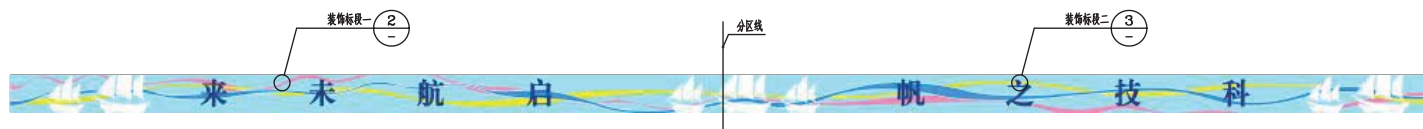

① 帆船雕塑处BK2198+190-BK2198+010声屏障装饰图 1:300

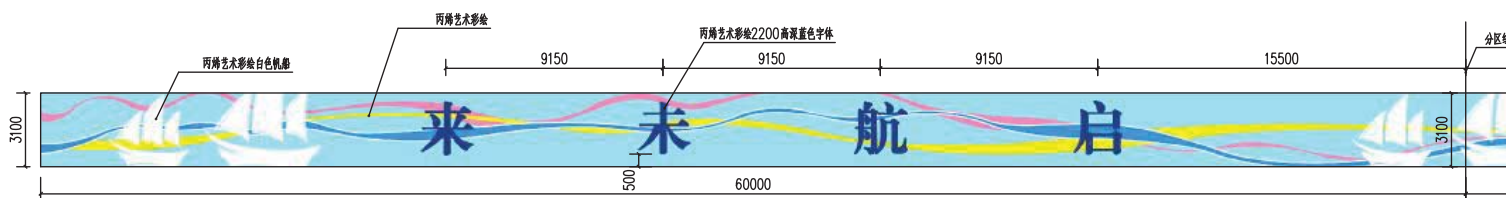

② 帆船雕塑处BK2198+190-BK2198+010声屏障装饰图标段一 1:150

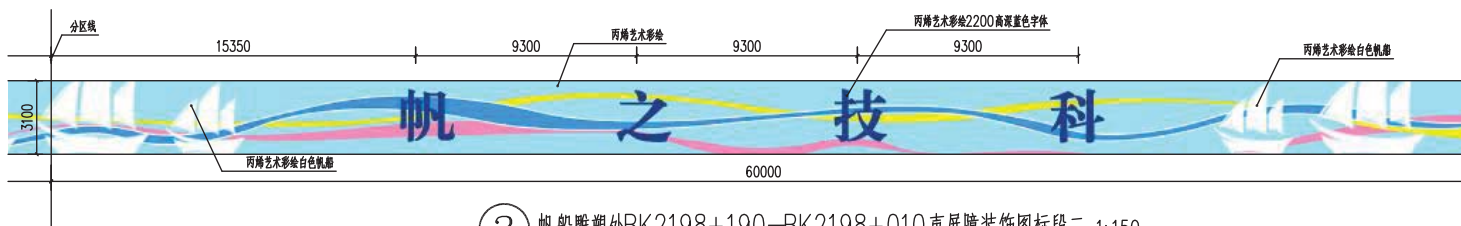

③ 帆船雕塑处BK2198+190-BK2198+010声屏障装饰图标段二 1:150











